

KOMATSU®

PC200-8 PC200LC-8

HORSEPOWER

Gross: 116 kW 155 HP @ 2000 rpm

Net: 110 kW 148 HP @ 2000 rpm

OPERATING WEIGHT

PC200-8: 19400–20010 kg

42,770–44,110 lb

PC200LC-8: 20630–21460 kg

45,480–47,310 lb

ecot3

PC
200



Photo may include optional equipment.

HYDRAULIC EXCAVATOR

WALK-AROUND

Ecology and Economy Features

- **Low fuel consumption by total control of the engine, hydraulic and electronic system.**

Reduces fuel consumption by approx. 10%.
(Compared with the PC200-7)

- **Low emission engine**

A powerful, turbocharged and air-to-air aftercooled Komatsu SAA6D107E-1 provides **110 kW** 148 HP. This engine is EPA Tier 3 and EU Stage 3A emissions certified, without sacrificing power or machine productivity.

- Economy mode improves fuel consumption.
- Eco-gauge for energy-saving operations
- Extended idling caution for fuel conservation

- **Low operation noise**

The dynamic noise is lowered by 2 dB compared with the PC200-7, realizing a low noise operation.

See page 4 and 5.

Safety Design

- Cab dedicated to hydraulic excavator for protecting the operator in the event of a roll over accident.
- Slip-resistant plates for safe work on machine
- Safety enhancement with large side-view, sidewise, and rear mirrors added.
- Rear view monitoring system for easy checking behind the machine (optional)
- ROPS cab (ISO 12117-2)

See page 7.



Large TFT LCD monitor

- Easy-to-see and use 7" large multi-function color monitor
- Can be displayed in 12 languages for global support.

TFT : Thin Film Transistor
LCD : Liquid Crystal Display

See page 8.

Large Comfortable Cab

- Low-noise cab, similar to passenger car
- Low vibration with cab damper mounting
- Highly pressurized cab with optional air conditioner
- Operator seat and console with armrest that enables operations in the appropriate operational posture.

See pages 6.

Easy Maintenance

- Long replacement interval of engine oil, engine oil filter, and hydraulic filter
- Remote mounted engine oil filter and fuel drain valve for easy access
- Equipped with the fuel pre-filter as standard (with water separator)
- Side-by-side cooling concept enables individual cooling modules to be serviced.
- Equipped with the EMMS monitoring system

See page 9.

HORSEPOWER

Gross: 116 kW 155 HP @ 2000 rpm

Net: 110 kW 148 HP @ 2000 rpm

OPERATING WEIGHT

PC200-8: 19400 – 20010 kg

42,770 – 44,110 lb

PC200LC-8: 20630 – 21460 kg

45,480 – 47,310 lb

BUCKET CAPACITY

0.50 – 1.17 m³

0.65 – 1.53 yd³



Photo may include optional equipment.

ECOLOGY & ECONOMY FEATURES

Komatsu Technology



Komatsu develops and produces all major components, such as engines, electronics and hydraulic components, in house. With this “Komatsu Technology,” and adding customer feedback, Komatsu is achieving great advancements in technology. To achieve both high levels of productivity and economical performance, Komatsu has developed the main components with a total control system. The result is a new generation of high performance and environment-friendly excavators.

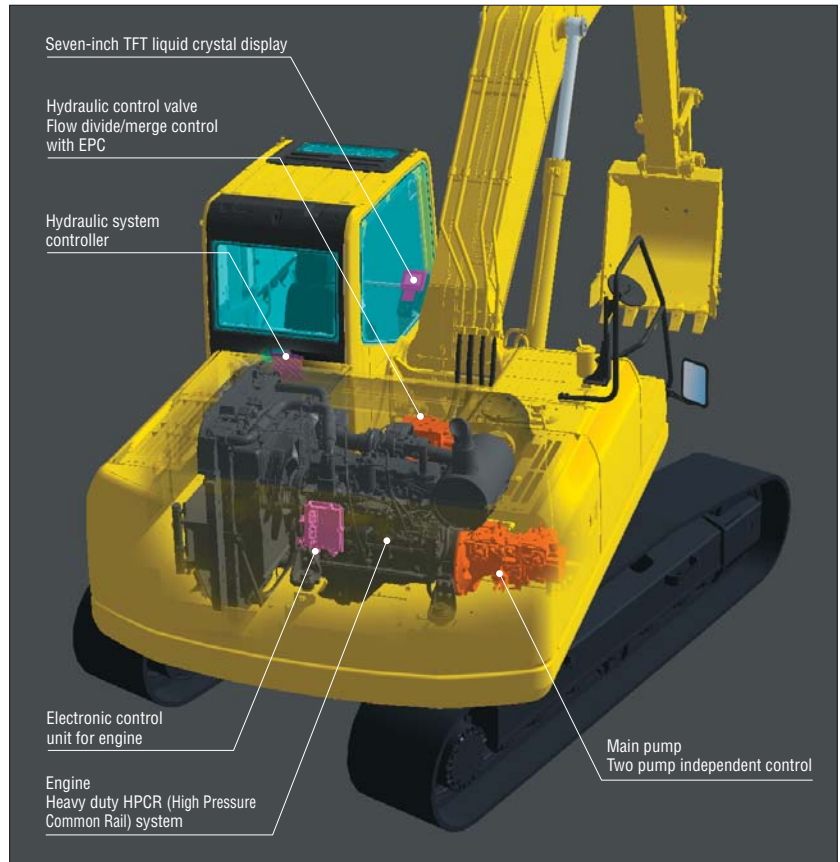

Low Fuel Consumption

The newly-developed Komatsu SAA6D107E-1 [ecot3] engine enables NOx emissions to be significantly reduced with the accurate multi-staged fuel injection by the engine controller. It improves total engine durability using the high-pressure fuel injection system developed specifically for construction machinery. This excavator significantly reduces hourly fuel consumption using the highly-efficient matching techniques of the engine and hydraulic unit and also provides features that promote energy-saving operations such as the E mode and Eco-gauge.

Fuel consumption 10% reduced

Compared with the PC200-7 at P mode and 100% working efficiency. Fuel consumption varies depending on job conditions.

Low Emission Engine

Komatsu SAA6D107E-1 engine is EPA Tier 3 and EU Stage 3A emissions certified and reduced NOx emission by 29% compared with the PC200-7.



ecot3
ecology & economy - technology 3

Low Operation Noise

Enables a low noise operation using the low-noise engine and methods to cut noise at source.

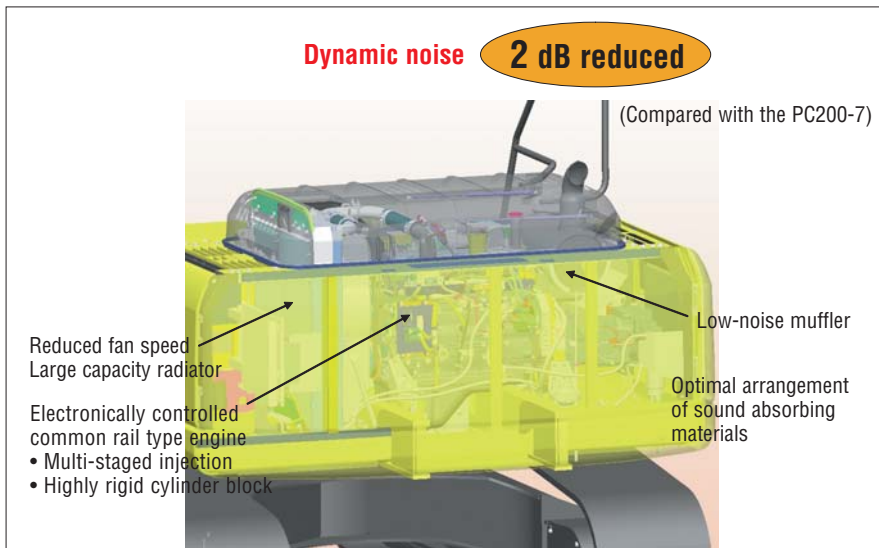

Working Modes Selectable

Two established work modes are further improved.

P mode – Power or work priority mode has low fuel consumption, but fast equipment speed and maximum production and power are maintained.

E mode – Economy or fuel priority mode further reduces fuel consumption, but maintains the P-mode-like working equipment speed for light duty work.

You can select Power or Economy modes using a one-touch operation on the monitor panel depending on workloads.

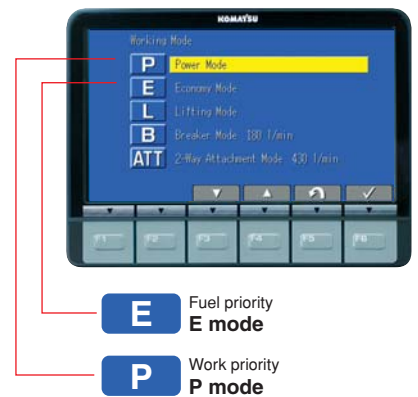

Eco-gauge that Assists Energy-saving Operations

Equipped with the Eco-gauge that can be recognized at a glance on the right of the multi-function color monitor for environment-friendly energy-saving operations. Allows focus on operation in the green range with reduced CO2 emissions and efficient fuel consumption.

Idling Caution

To prevent unnecessary fuel consumption, an idling caution is displayed on the monitor, if the engine idles for 5 minutes or more.



Eco-gauge

WORKING ENVIRONMENT



Low Cab Noise

The newly-designed cab is highly rigid and has excellent sound absorption ability. Thorough improvement of noise source reduction and use of low noise engine, hydraulic equipment, and air conditioner allows this machine to generate a low level of noise similar to that of a passenger car.

Low Vibration with Cab Damper Mounting

PC200-8 uses viscous damper mounting for cab that incorporates longer stroke and the addition of a spring. The new cab damper mounting combined with high rigidity deck aids vibration reduction at operator seat.

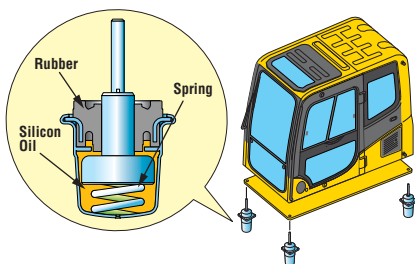

Wide Newly-designed Cab

Newly-designed wide spacious cab includes seat with reclining backrest. The seat height and longitudinal inclination are easily adjusted using a pull-up lever. You can set the appropriate operational posture of armrest together with the console.

Reclining the seat further enables you to place it into the fully flat state with the headrest attached.



Pressurized Cab

Optional air conditioner, air filter and a higher internal air pressure (+6.0 mm Aq +0.2" Aq) prevent external dust from entering the cab.

Automatic Air Conditioner (optional)

Enables you to easily and precisely set cab atmosphere with the instruments on the large LCD.



The bi-level control function keeps the operator's head and feet cool and warm respectively. This improved air flow function keeps the inside of the cab comfortable throughout the year. Defroster function keeps front glass clear.

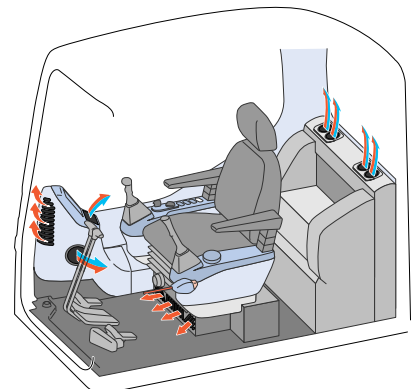

Safety Features

ROPS Cab

The machine is equipped with a ROPS cab that conforms to ISO 12117-2 for excavators as standard equipment. The ROPS cab has high shock-absorption performance, featuring excellent durability and impact strength. It also satisfies the requirements of ISO OPG top guard level 1 for falling objects. Combined with the retractable seat belt, The ROPS cab protects the operator in case of tipping over and against falling objects.



Slip-resistant Plates

Highly durable slip-resistant plates maintain superior traction performance for the long term.



Pump/engine Room Partition

Pump/engine room partition prevents oil from spraying onto the engine if a hydraulic hose should burst.

Lock Lever

Locks the hydraulic pressure to prevent unintentional movement. Neutral start function allows machine to be started only in lock position.



Large Side-view, Rear, and Sidewise Mirrors

Enlarged left-side mirror and addition of rear and side mirror allow the PC200-8 to meet the new ISO visibility requirements.



Rear View Monitoring System (optional)

The operator can view the rear of the machine with a color monitor screen.



Monitor for rear view camera

Thermal and Fan Guards

Thermal and fan guards are placed around high-temperature parts of the engine and fan drive.

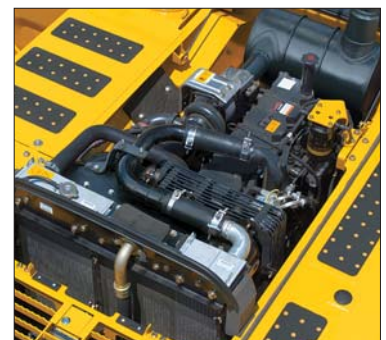

Large LCD Color Monitor

Large Multi-lingual LCD Monitor

A large user-friendly color monitor enables safe, accurate and smooth work. Improved screen visibility is achieved by the use of TFT liquid crystal display that can easily be read at various angles and lighting conditions. Simple and easy to operate switches. Industry first function keys facilitate multi-function operations. Displays data in 12 languages to globally support operators around the world.



Indicators

- | | |
|----------------------------------|-----------------------------------|
| 1 Auto-decelerator | 5 Hydraulic oil temperature gauge |
| 2 Working mode | 6 Fuel gauge |
| 3 Travel speed | 7 Eco-gauge |
| 4 Engine water temperature gauge | 8 Function switches menu |

Basic operation switches

- | | |
|-------------------------|---------------------|
| 1 Auto-decelerator | 4 Buzzer cancel |
| 2 Working mode selector | 5 Wiper |
| 3 Traveling selector | 6 Windshield washer |

Mode Selection

The multi-function color monitor has Power mode, Economy mode, Lifting mode, Breaker mode and Attachment mode.

Working Mode	Application	Advantage
P	Power mode	<ul style="list-style-type: none"> Maximum production/power Fast cycle time
E	Economy mode	<ul style="list-style-type: none"> Excellent fuel economy
L	Lifting mode	<ul style="list-style-type: none"> Hydraulic pressure is increased by 7%
B	Breaker operation	<ul style="list-style-type: none"> Optimum engine rpm, hydraulic flow
ATT	Attachment mode	<ul style="list-style-type: none"> Optimum engine rpm, hydraulic flow, 2 way

Lifting Mode

When the Lifting mode is selected, lifting capacity is increased 7% by raising hydraulic pressure.

EMMS

(Equipment Management Monitoring System)

Monitor Function

Controller monitors engine oil level, coolant temperature, battery charge and air clogging, etc. If controller finds any abnormality, it is displayed on the LCD.



Maintenance Function

Monitor informs replacement time of oil and filters on LCD when the replacement interval is reached.



Trouble Data Memory Function

Monitor stores abnormalities for effective troubleshooting.

MAINTENANCE FEATURES

Side-by-side Cooling

Since radiator, aftercooler and oil cooler are arranged in parallel, it is easy to clean, remove and install them.

Radiator, aftercooler, and oil cooler made of aluminum have high cooling efficiency and are easily recycled.



Equipped with the Fuel Pre-filter (with Water Separator)

Removes water and contaminants in the fuel to prevent fuel problems. (With built-in priming pump)



Washable Cab Floor Mat

The PC200-8's cab floor mat is easy to keep clean. The gently inclined surface has a flanged floor mat and drainage holes to facilitate runoff.



Easy Access to Engine Oil Filter and Fuel Drain Valve

Engine oil filter and fuel drain valve are remote mounted to improve accessibility.



Equipped with the Eco-drain Valve as Standard.

Prevents clothes and the ground from becoming contaminated due to oil leakage when replacing the engine oil.



Large-capacity Fuel Tank and Rustproof Treatment

400-liter (106 U.S. gal) high-capacity fuel tank. Effective corrosion resistance using rust-proof treatment.

Sloping Track Frame

Prevents dirt and sand from accumulating and allows easy mud removal.

Gas Assisted Engine Hood Damper Cylinders

The engine hood can be easily opened and closed with the assistance of the gas assisted engine hood damper cylinders.



Long-life Oil, Filter

Uses high-performance filtering materials and long-life oil. Extends the oil and filter replacement interval.



Hydraulic oil filter (Eco-white element)

Engine oil & Engine oil filter	every 500 hours
Hydraulic oil	every 5000 hours
Hydraulic oil filter	every 1000 hours

Air Conditioner Filter (optional)

The air conditioner filter is removed and installed without the use of tools facilitating filter maintenance.



Internal air conditioner filter



External air conditioner filter

Long Work Equipment Greasing Interval (optional)

High quality BMRC bushings and resin shims are optionally available for work equipment pins excluding bucket, extending greasing interval to 500 hours.

SPECIFICATIONS



ENGINE

Model Komatsu SAA6D107E-1
 Type Water-cooled, 4-cycle, direct injection
 Aspiration Turbocharged, aftercooled
 Number of cylinders 6
 Bore **107 mm** 4.21"
 Stroke **124 mm** 4.88"
 Piston displacement **6.69 ltr** 408 in³
 Horsepower:
 SAE J1995 Gross **116 kW** 155 HP
 ISO 9249 / SAE J1349 Net **110 kW** 148 HP
 Rated rpm 2000 rpm
 Fan drive method for radiator cooling Mechanical Governor
 EPA Tier 3 and EU Stage 3A emissions certified.



HYDRAULICS

Type HydraMind (Hydraulic Mechanical Intelligence New Design) system, closed-center system with load sensing valves and pressure compensated valves
 Number of selectable working modes 5
 Main pump:
 Type Variable displacement piston type
 Pumps for Boom, arm, bucket, swing, and travel circuits
 Maximum flow **439 ltr/min** 116 U.S. gal/min
 Supply for control circuit Self-reducing valve
 Hydraulic motors:
 Travel 2 x axial piston motor with parking brake
 Swing 1 x axial piston motor with swing holding brake
 Relief valve setting:
 Implement circuits **37.3 MPa** 380 kgf/cm² 5,400 psi
 Travel circuit **37.3 MPa** 380 kgf/cm² 5,400 psi
 Swing circuit **28.9 MPa** 295 kgf/cm² 4,190 psi
 Pilot circuit **3.2 MPa** 33 kgf/cm² 470 psi
 Hydraulic cylinders:
 (Number of cylinders – bore x stroke x rod diameter)
 Boom **2–120 mm x 1334 mm x 85 mm** 4.7" x 52.5" x 3.3"
 Arm **1–135 mm x 1490 mm x 95 mm** 5.3" x 58.7" x 3.7"
 Bucket: for **2.41 m** 7'11" and **2.93 m** 9'7" Arm
 1–115 mm x 1120 mm x 80 mm 4.5" x 44.1" x 3.2"
 for **1.84 m** 6'0" Arm
 1–125 mm x 1110 mm x 85 mm 4.9" x 43.7" x 3.3"



DRIVES AND BRAKES

Steering control Two levers with pedals
 Drive method Hydrostatic
 Maximum drawbar pull **178 kN** 18200 kg 40,120 lb
 Gradeability 70%, 35°
 Maximum travel speed: High **5.5 km/h** 3.4 mph
 (Auto-Shift) Mid **4.1 km/h** 2.5 mph
 (Auto-Shift) Low **3.0 km/h** 1.9 mph
 Service brake Hydraulic lock
 Parking brake Mechanical disc brake



SWING SYSTEM

Drive method Hydrostatic
 Swing reduction Planetary gear
 Swing circle lubrication Grease-bathed
 Service brake Hydraulic lock
 Holding brake/Swing lock Mechanical disc brake
 Swing speed 12.4 rpm



UNDERCARRIAGE

Center frame X-frame
 Track frame Box-section
 Seal of track Sealed track
 Track adjuster Hydraulic
 Number of shoes (each side):
 PC200-8 45
 PC200LC-8 49
 Number of carrier rollers 2 each side
 Number of track rollers (each side):
 PC200-8 7
 PC200LC-8 9



COOLANT AND LUBRICANT CAPACITY (REFILLING)

Fuel tank **400 ltr** 105.7 U.S. gal
 Coolant **20.4 ltr** 5.4 U.S. gal
 Engine **23.1 ltr** 6.1 U.S. gal
 Final drive, each side **3.3 ltr** 0.9 U.S. gal
 Swing drive **6.6 ltr** 1.7 U.S. gal
 Hydraulic tank **135 ltr** 35.7 U.S. gal



OPERATING WEIGHT (APPROXIMATE)

Operating weight including **5700 mm** 18'8" one-piece boom, **2925 mm** 9'7" arm, SAE heaped **0.80 m³** 1.05 yd³ backhoe bucket, rated capacity of lubricants, coolant, full fuel tank, operator, and standard equipment.

Shoes	PC200-8		PC200LC-8	
	Operating Weight	Ground Pressure	Operating Weight	Ground Pressure
500 mm 20"	19400 kg 42,770 lb	53.0 kPa 0.54 kgf/cm ² 7.68 psi	—	—
600 mm 24"	19500 kg 42,990 lb	45.1 kPa 0.46 kgf/cm ² 6.54 psi	20630 kg 45,480 lb	43.1 kPa 0.44 kgf/cm ² 6.26 psi
700 mm 28"	19750 kg 43,540 lb	39.2 kPa 0.40 kgf/cm ² 5.69 psi	20900 kg 46,080 lb	37.3 kPa 0.38 kgf/cm ² 5.40 psi
800 mm 31.5"	20010 kg 44,110 lb	34.3 kPa 0.35 kgf/cm ² 4.98 psi	21180 kg 46,690 lb	33.3 kPa 0.34 kgf/cm ² 4.83 psi
900 mm 35.5"	—	—	21460 kg 47,310 lb	29.4 kPa 0.30 kgf/cm ² 4.27 psi



DIMENSIONS

	Arm Length	1840 mm 6'0"	2410 mm 7'11"	2925 mm 9'7"
A	Overall length	9480 mm 31'1"	9495 mm 31'2"	9425 mm 30'11"
B	Length on ground (transport): PC200-8 PC200LC-8	6270 mm 20'7" 6455 mm 21'2"	5700 mm 18'8" 5885 mm 19'4"	4815 mm 15'10" 5000 mm 16'5"
C	Overall height (to top of boom)	2985 mm 9'10"	3190 mm 10'6"	2970 mm 9'9"

	PC200-8	PC200LC-8	
D	Overall width	2800 mm 9'2"	3080 mm 10'1"
E	Overall height (to top of cab)	3040 mm 10'0"	3040 mm 10'0"
F	Ground clearance, counterweight	1085 mm 3'7"	1085 mm 3'7"
G	Ground clearance (minimum)	440 mm 1'5"	440 mm 1'5"
H	Tail swing radius	2750 mm 9'0"	2750 mm 9'0"
I	Track length on ground	3275 mm 10'9"	3655 mm 12'0"
J	Track length	4070 mm 13'4"	4450 mm 14'7"
K	Track gauge	2200 mm 7'3"	2380 mm 7'10"
L	Width of crawler	2800 mm 9'2"	3080 mm 10'1"
M	Shoe width	600 mm 24"	700 mm 28"
N	Grouser height	26 mm 1.0"	26 mm 1.0"
O	Machine cab height	2095 mm 6'10"	2095 mm 6'10"
P	Machine cab width	2710 mm 8'11"	2710 mm 8'11"
Q	Distance, swing center to rear end	2710 mm 8'11"	2710 mm 8'11"

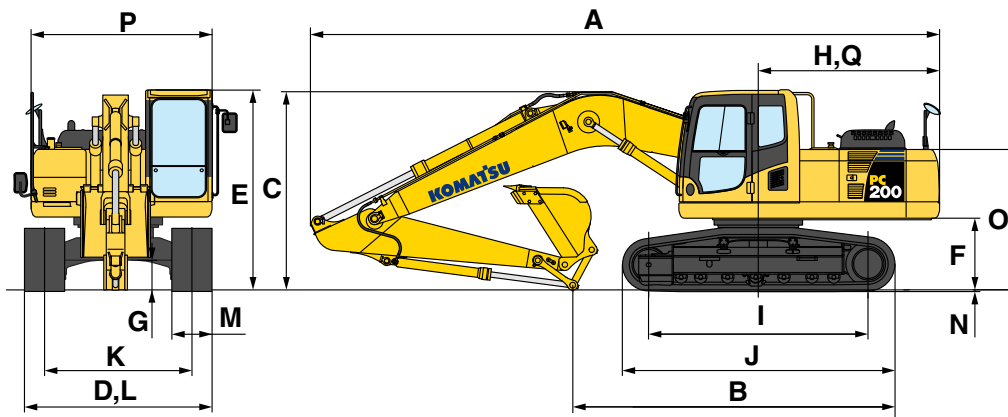

BACKHOE BUCKET, ARM, AND BOOM COMBINATION

Bucket Capacity (heaped)		Width		Weight		Number of Teeth	Arm Length		
SAE, PCSA	CECE	Without Side Cutters	With Side Cutters	With Side Cutters			1.84 m 6'0"	2.41 m 7'11"	2.93 m 9'7"
0.50 m ³ 0.65 yd ³	0.45 m ³ 0.59 yd ³	750 mm 29.5"	875 mm 34.4"	478 kg 1,050 lb		3	○	○	○
0.80 m ³ 1.05 yd ³	0.70 m ³ 0.92 yd ³	1045 mm 41.1"	1170 mm 46.1"	635 kg 1,400 lb		5	○	○	○
0.93 m ³ 1.22 yd ³	0.80 m ³ 1.05 yd ³	1200 mm 47.2"	1325 mm 52.2"	696 kg 1,530 lb		5	□	□	●
1.05 m ³ 1.37 yd ³	0.90 m ³ 1.18 yd ³	1330 mm 52.4"	1455 mm 57.3"	757 kg 1,670 lb		6	□	□	X
1.17 m ³ 1.53 yd ³	1.00 m ³ 1.31 yd ³	1450 mm 57.1"	—	940 kg 2,070 lb		6	●	●	X

○: General purpose use, density up to 1.8 ton/m³ 1.52 U.S. ton/yd³ ●: Light duty work, density up to 1.2 ton/m³ 1.01 U.S. ton/yd³
 □: General purpose use, density up to 1.5 ton/m³ 1.26 U.S. ton/yd³ X: Not usable



WORKING RANGE

	Arm	1840 mm 6'0"	2410 mm 7'11"	2925 mm 9'7"
A	Max. digging height	9500 mm 31'2"	9800 mm 32'2"	10000 mm 32'10"
B	Max. dumping height	6630 mm 21'9"	6890 mm 22'7"	7110 mm 23'4"
C	Max. digging depth	5380 mm 17'8"	6095 mm 20'0"	6620 mm 21'9"
D	Max. vertical wall digging depth	4630 mm 15'2"	5430 mm 17'10"	5980 mm 19'7"
E	Max. digging depth of cut for 8' level	5130 mm 16'0"	5780 mm 19'0"	6370 mm 20'11"
F	Max. digging reach	8850 mm 29'1"	9380 mm 30'9"	9875 mm 32'5"
G	Max. digging reach at ground level	8660 mm 28'5"	9190 mm 30'2"	9700 mm 31'10"
H	Min. swing radius	3010 mm 9'11"	3090 mm 10'2"	3040 mm 10'0"
SAE rating	Bucket digging force at power max.	157 kN 16000 kgf/35,270 lb	138 kN 14100 kgf/31,080 lb	138 kN 14100 kgf/31,080 lb
	Arm crowd force at power max.	139 kN 14200 kgf/31,300 lb	124 kN 12600 kgf/27,780 lb	101 kN 10300 kgf/22,710 lb
ISO rating	Bucket digging force at power max.	177 kN 18000 kgf/39,680 lb	149 kN 15200 kgf/33,510 lb	149 kN 15200 kgf/33,510 lb
	Arm crowd force at power max.	145 kN 14800 kgf/32,630 lb	127 kN 13000 kgf/28,660 lb	108 kN 11000 kgf/24,250 lb

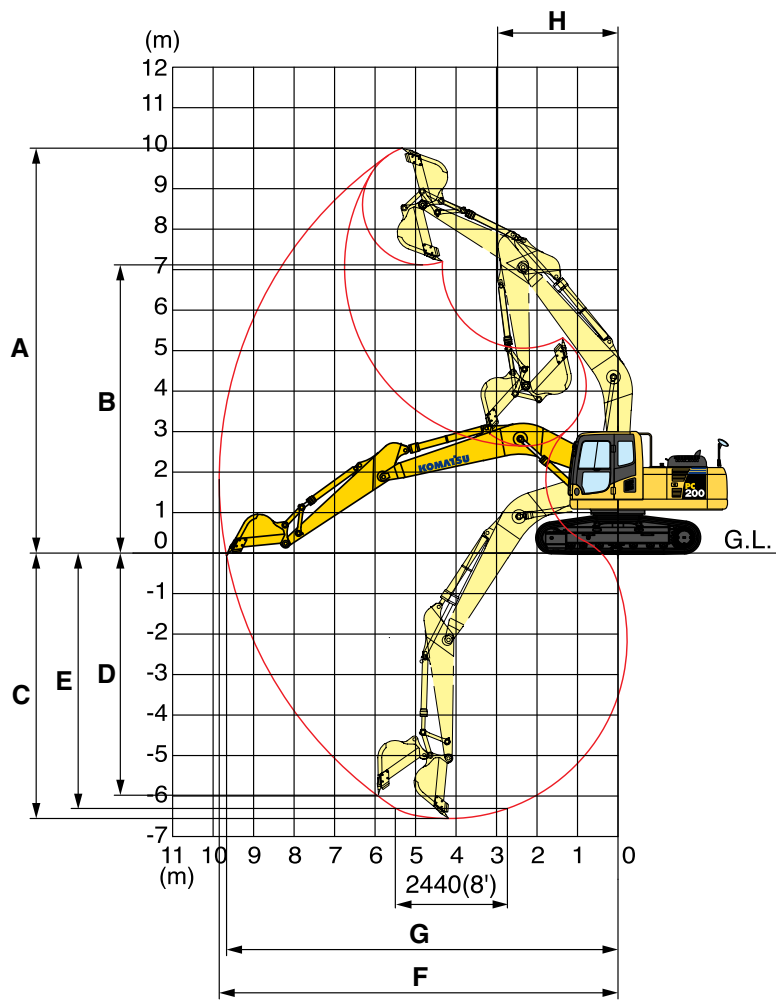



LIFTING CAPACITY WITH LIFTING MODE

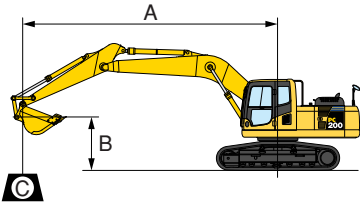

- A: Reach from swing center
- B: Bucket hook height
- C: Lifting capacity
- Cf: Rating over front
- Cs: Rating over side
- ⊗: Rating at maximum reach

Conditions:

- 5700 mm 18"8" one-piece boom
- 0.8 m³ 1.05 yd³ SAE heaped bucket
- Shoe width:
—PC200-8 600 mm 24" triple grouser

PC200-8		Arm: 1840 mm 6'0"				Bucket: 0.8 m ³ 1.05 yd ³ SAE heaped				Shoe: 600 mm 24" triple grouser			
B	A	⊗ MAX		7.6 m 25'		6.1 m 20'		4.6 m 15'		3.0 m 10'		1.5 m 5'	
		Cf	Cs	Cf	Cs	Cf	Cs	Cf	Cs	Cf	Cs	Cf	Cs
7.6 m 25'		*4800 kg *10,600 lb	*4800 kg *10,600 lb					*5500 kg *12,100 lb	*5500 kg *12,100 lb				
6.1 m 20'		*4450 kg *9,900 lb	3450 kg 7,600 lb			*5450 kg *12,100 lb	3800 kg 8,300 lb	*5700 kg *12,600 lb	*5700 kg *12,600 lb				
4.6 m 15'		4200 kg 9,300 lb	2700 kg 6,000 lb			5650 kg 12,500 lb	3700 kg 8,100 lb	*7000 kg *15,400 lb	6000 kg 13,200 lb	*9850 kg *21,800 lb	*9850 kg *21,800 lb		
3.0 m 10'		3750 kg 8,300 lb	2350 kg 5,200 lb			5450 kg 12,000 lb	3500 kg 7,700 lb	8600 kg 19,000 lb	5350 kg 11,800 lb				
1.5 m 5'		3600 kg 8,000 lb	2250 kg 5,000 lb	3650 kg 8,100 lb	2300 kg 5,000 lb	5250 kg 11,500 lb	3300 kg 7,300 lb	8250 kg 18,200 lb	5000 kg 11,100 lb				
0 m 0'		3750 kg 8,200 lb	2300 kg 5,100 lb			5100 kg 11,200 lb	3150 kg 7,000 lb	8050 kg 17,700 lb	4850 kg 10,700 lb				
-1.5 m -5'		4200 kg 9,300 lb	2650 kg 5,800 lb			5050 kg 11,200 lb	3150 kg 6,900 lb	8050 kg 17,700 lb	4850 kg 10,700 lb	*13350 kg *29,400 lb	9500 kg 21,000 lb		
-3.0 m -10'		5500 kg 12,100 lb	3450 kg 7,600 lb					8200 kg 18,100 lb	5000 kg 11,000 lb	*13200 kg *29,100 lb	9800 kg 21,600 lb		

PC200-8		Arm: 2410 mm 7'11"				Bucket: 0.8 m ³ 1.05 yd ³ SAE heaped				Shoe: 600 mm 24" triple grouser			
B	A	⊗ MAX		7.6 m 25'		6.1 m 20'		4.6 m 15'		3.0 m 10'		1.5 m 5'	
		Cf	Cs	Cf	Cs	Cf	Cs	Cf	Cs	Cf	Cs	Cf	Cs
7.6 m 25'		*4300 kg *9,500 lb	4300 kg 9,400 lb										
6.1 m 20'		*4100 kg *9,000 lb	3000 kg 6,600 lb			*4850 kg *10,700 lb	3950 kg 8,700 lb						
4.6 m 15'		3800 kg 8,400 lb	2450 kg 5,400 lb	3900 kg 8,600 lb	2500 kg 5,600 lb	*5400 kg *11,900 lb	3800 kg 8,400 lb	*6200 kg *13,600 lb	*6200 kg *13,600 lb				
3.0 m 10'		3400 kg 7,500 lb	2150 kg 4,800 lb	3800 kg 8,400 lb	2450 kg 5,400 lb	5600 kg 12,300 lb	3600 kg 8,000 lb	*8100 kg *17,800 lb	5700 kg 12,600 lb				
1.5 m 5'		3300 kg 7,300 lb	2050 kg 4,600 lb	3700 kg 8,200 lb	2350 kg 5,200 lb	5350 kg 11,800 lb	3400 kg 7,500 lb	8450 kg 18,700 lb	5250 kg 11,500 lb				
0 m 0'		3400 kg 7,500 lb	2100 kg 4,700 lb	3650 kg 8,000 lb	2250 kg 5,000 lb	5150 kg 11,400 lb	3250 kg 7,100 lb	8150 kg 18,000 lb	4950 kg 11,000 lb	*7350 kg *16,200 lb	*7350 kg *16,200 lb		
-1.5 m -5'		3750 kg 8,300 lb	2350 kg 5,200 lb			5100 kg 11,200 lb	3150 kg 7,000 lb	8100 kg 17,800 lb	4900 kg 10,800 lb	*12250 kg *27,000 lb	9500 kg 21,000 lb	*7650 kg *16,900 lb	*7650 kg *16,900 lb
-3.0 m -10'		4650 kg 10,200 lb	2900 kg 6,400 lb			5150 kg 11,400 lb	3200 kg 7,100 lb	8200 kg 18,000 lb	4950 kg 11,000 lb	*14700 kg *32,400 lb	9750 kg 21,500 lb	*12650 kg *27,900 lb	*12650 kg *27,900 lb
-4.6 m -15'		*7200 kg *15,900 lb	4550 kg 10,000 lb					*8100 kg *17,800 lb	5200 kg 11,500 lb	*11600 kg *25,500 lb	10150 kg 22,400 lb		

PC200-8		Arm: 2925 mm 9'7"				Bucket: 0.8 m ³ 1.05 yd ³ SAE heaped				Shoe: 600 mm 24" triple grouser			
B	A	⊗ MAX		7.6 m 25'		6.1 m 20'		4.6 m 15'		3.0 m 10'		1.5 m 5'	
		Cf	Cs	Cf	Cs	Cf	Cs	Cf	Cs	Cf	Cs	Cf	Cs
7.6 m 25'		*2750 kg *6,100 lb	*2750 kg *6,100 lb			*3800 kg *8,300 lb	*3800 kg *8,300 lb						
6.1 m 20'		*2600 kg *5,800 lb	*2600 kg *5,800 lb			*4300 kg *9,500 lb	4050 kg 8,900 lb						
4.6 m 15'		*2650 kg *5,800 lb	2150 kg 4,800 lb	3950 kg 8,800 lb	2600 kg 5,700 lb	*4900 kg *10,800 lb	3900 kg 8,600 lb						
3.0 m 10'		*2800 kg *6,100 lb	1950 kg 4,300 lb	3850 kg 8,500 lb	2500 kg 5,500 lb	5650 kg 12,500 lb	3700 kg 8,100 lb	*7350 kg *16,200 lb	5850 kg 12,900 lb	*11350 kg *25,000 lb	*11350 kg *25,000 lb		
1.5 m 5'		3000 kg 6,600 lb	1850 kg 4,100 lb	3750 kg 8,300 lb	2350 kg 5,200 lb	5400 kg 11,900 lb	3450 kg 7,600 lb	8600 kg 19,000 lb	5350 kg 11,800 lb	*7500 kg *16,500 lb	*7500 kg *16,500 lb		
0 m 0'		3050 kg 6,700 lb	1900 kg 4,200 lb	3650 kg 8,000 lb	2300 kg 5,000 lb	5200 kg 11,500 lb	3250 kg 7,200 lb	8250 kg 18,200 lb	5050 kg 11,100 lb	*8000 kg *17,700 lb	*8000 kg *17,700 lb		
-1.5 m -5'		3350 kg 7,400 lb	2050 kg 4,600 lb	3600 kg 7,900 lb	2250 kg 4,900 lb	5100 kg 11,200 lb	3150 kg 7,000 lb	8100 kg 17,900 lb	4900 kg 10,800 lb	*11200 kg *24,700 lb	9500 kg 20,900 lb	*6800 kg *15,000 lb	*6800 kg *15,000 lb
-3.0 m -10'		4000 kg 8,800 lb	2500 kg 5,500 lb			5100 kg 11,200 lb	3150 kg 7,000 lb	8100 kg 17,900 lb	4950 kg 10,900 lb	*15600 kg *34,400 lb	9650 kg 21,300 lb	*10550 kg *23,200 lb	*10550 kg *23,200 lb
-4.6 m -15'		5650 kg 12,500 lb	3550 kg 7,900 lb					8300 kg 18,300 lb	5100 kg 11,200 lb	*13050 kg *28,800 lb	10000 kg 22,000 lb		

* Load is limited by hydraulic capacity rather than tipping. Ratings are based on SAE Standard No. J1097. Rated loads do not exceed 87% of hydraulic lift capacity or 75% of tipping load.



LIFTING CAPACITY WITH LIFTING MODE

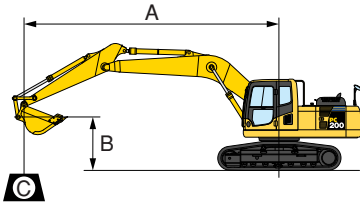

- A: Reach from swing center
- B: Bucket hook height
- C: Lifting capacity
- Cf: Rating over front
- Cs: Rating over side
- ⊗: Rating at maximum reach

Conditions:

- 5700 mm 18'8" one-piece boom
- 0.8 m³ 1.05 yd³ SAE heaped bucket
- Shoe width:
—PC200LC-8 700 mm 28" triple grouser

PC200LC-8		Arm: 1840 mm 6'0"				Bucket: 0.8 m ³ 1.05 yd ³ SAE heaped				Shoe: 700 mm 28" triple grouser			
B	A	⊗ MAX		7.6 m 25'		6.1 m 20'		4.6 m 15'		3.0 m 10'		1.5 m 5'	
		Cf	Cs	Cf	Cs	Cf	Cs	Cf	Cs	Cf	Cs	Cf	Cs
7.6 m 25'		*4800 kg *10,600 lb	*4800 kg *10,600 lb					*5500 kg *12,100 lb	*5500 kg *12,100 lb				
6.1 m 20'		*4450 kg *9,900 lb	3950 kg 8,800 lb			*5450 kg *12,100 lb	4350 kg 9,600 lb	*5700 kg *12,600 lb	*5700 kg *12,600 lb				
4.6 m 15'		*4500 kg *9,900 lb	3150 kg 7,000 lb			*5900 kg *13,000 lb	4250 kg 9,400 lb	*7000 kg *15,400 lb	6900 kg 15,200 lb	*9850 kg *21,800 lb	*9850 kg *21,800 lb		
3.0 m 10'		*4650 kg *10,200 lb	2800 kg 6,200 lb			*6700 kg *14,800 lb	4050 kg 9,000 lb	*8700 kg *19,200 lb	6250 kg 13,700 lb				
1.5 m 5'		4500 kg 9,900 lb	2650 kg 5,900 lb	4550 kg 10,000 lb	2700 kg 6,000 lb	6500 kg 14,300 lb	3850 kg 8,500 lb	*10350 kg *22,800 lb	5900 kg 13,000 lb				
0 m 0'		4650 kg 10,300 lb	2750 kg 6,100 lb			6350 kg 14,000 lb	3750 kg 8,200 lb	10200 kg 22,500 lb	5700 kg 12,600 lb				
-1.5 m -5'		5250 kg 11,600 lb	3100 kg 6,900 lb			6350 kg 14,000 lb	3700 kg 8,200 lb	10200 kg 22,500 lb	5700 kg 12,600 lb	*13350 kg *29,400 lb	11350 kg 25,100 lb		
-3.0 m -10'		6850 kg 15,100 lb	4050 kg 8,900 lb					*9550 kg *21,100 lb	5900 kg 13,000 lb	*13200 kg *29,100 lb	11700 kg 25,800 lb		

PC200LC-8		Arm: 2410 mm 7'11"				Bucket: 0.8 m ³ 1.05 yd ³ SAE heaped				Shoe: 700 mm 28" triple grouser			
B	A	⊗ MAX		7.6 m 25'		6.1 m 20'		4.6 m 15'		3.0 m 10'		1.5 m 5'	
		Cf	Cs	Cf	Cs	Cf	Cs	Cf	Cs	Cf	Cs	Cf	Cs
7.6 m 25'		*4300 kg *9,500 lb	*4300 kg *9,500 lb										
6.1 m 20'		*4100 kg *9,000 lb	3500 kg 7,700 lb			*4850 kg *10,700 lb	4500 kg 10,000 lb						
4.6 m 15'		*4150 kg *9,100 lb	2850 kg 6,300 lb	*4700 kg *10,400 lb	2950 kg 6,500 lb	*5400 kg *11,900 lb	4400 kg 9,700 lb	*6200 kg *13,600 lb	*6200 kg *13,600 lb				
3.0 m 10'		*4250 kg *9,300 lb	2550 kg 5,600 lb	4700 kg 10,400 lb	2850 kg 6,300 lb	*6300 kg *13,900 lb	4200 kg 9,200 lb	*8100 kg *17,800 lb	6600 kg 14,600 lb				
1.5 m 5'		4100 kg 9,000 lb	2450 kg 5,400 lb	4600 kg 10,200 lb	2750 kg 6,100 lb	*6600 kg *14,500 lb	3950 kg 8,700 lb	*9850 kg *21,800 lb	6100 kg 13,500 lb				
0 m 0'		4200 kg 9,300 lb	2500 kg 5,500 lb	4550 kg 10,000 lb	2700 kg 5,900 lb	6450 kg 14,200 lb	3800 kg 8,400 lb	10350 kg 22,800 lb	5850 kg 12,900 lb	*7350 kg *16,200 lb	*7350 kg *16,200 lb		
-1.5 m -5'		4650 kg 10,300 lb	2750 kg 6,100 lb			6350 kg 14,000 lb	3750 kg 8,300 lb	10250 kg 22,600 lb	5800 kg 12,700 lb	*12250 kg *27,000 lb	11400 kg 25,100 lb	*7650 kg *16,900 lb	*7650 kg *16,900 lb
-3.0 m -10'		5750 kg 12,700 lb	3450 kg 7,600 lb			6400 kg 14,200 lb	3800 kg 8,400 lb	*10250 kg *22,600 lb	5850 kg 12,900 lb	*14700 kg *32,400 lb	11600 kg 25,600 lb	*12650 kg *27,900 lb	*12650 kg *27,900 lb
-4.6 m -15'		*7200 kg *15,900 lb	5300 kg 11,700 lb					*8100 kg *17,800 lb	6100 kg 13,500 lb	*11600 kg *25,500 lb	*11600 kg *25,500 lb		

PC200LC-8		Arm: 2925 mm 9'7"				Bucket: 0.8 m ³ 1.05 yd ³ SAE heaped				Shoe: 700 mm 28" triple grouser			
B	A	⊗ MAX		7.6 m 25'		6.1 m 20'		4.6 m 15'		3.0 m 10'		1.5 m 5'	
		Cf	Cs	Cf	Cs	Cf	Cs	Cf	Cs	Cf	Cs	Cf	Cs
7.6 m 25'		*2750 kg *6,100 lb	*2750 kg *6,100 lb			*3800 kg *8,300 lb	*3800 kg *8,300 lb						
6.1 m 20'		*2600 kg *5,800 lb	*2600 kg *5,800 lb			*4300 kg *9,500 lb	*4300 kg *9,500 lb						
4.6 m 15'		*2650 kg *5,800 lb	2550 kg 5,600 lb	*4650 kg *10,300 lb	3000 kg 6,600 lb	*4900 kg *10,800 lb	4500 kg 9,900 lb						
3.0 m 10'		*2800 kg *6,100 lb	2300 kg 5,100 lb	4750 kg 10,500 lb	2900 kg 6,400 lb	*5850 kg *12,900 lb	4250 kg 9,400 lb	*7350 kg *16,200 lb	6750 kg 14,900 lb	*11350 kg *25,000 lb	*11350 kg *25,000 lb		
1.5 m 5'		*3050 kg *6,700 lb	2200 kg 4,900 lb	4650 kg 10,200 lb	2800 kg 6,200 lb	6700 kg 14,700 lb	4000 kg 8,900 lb	*9300 kg *20,500 lb	6250 kg 13,800 lb	*7500 kg *16,500 lb	*7500 kg *16,500 lb		
0 m 0'		*3500 kg *7,800 lb	2250 kg 5,000 lb	4550 kg 10,000 lb	2700 kg 5,900 lb	6450 kg 14,300 lb	3850 kg 8,400 lb	10450 kg 23,000 lb	5900 kg 13,000 lb	*8000 kg *17,700 lb	*8000 kg *17,700 lb		
-1.5 m -5'		4150 kg 9,200 lb	2450 kg 5,400 lb	4500 kg 9,900 lb	2650 kg 5,800 lb	6350 kg 14,000 lb	3750 kg 8,200 lb	*10250 kg *22,700 lb	5800 kg 12,700 lb	*11200 kg *24,700 lb	*11200 kg *24,700 lb	*6800 kg *15,000 lb	*6800 kg *15,000 lb
-3.0 m -10'		4950 kg 11,000 lb	2950 kg 6,500 lb			6350 kg 14,000 lb	3750 kg 8,200 lb	10300 kg 22,700 lb	5800 kg 12,800 lb	*15600 kg *34,400 lb	11500 kg 25,400 lb	*10550 kg *23,200 lb	*10550 kg *23,200 lb
-4.6 m -15'		*6750 kg *14,900 lb	4150 kg 9,200 lb					*9050 kg *20,000 lb	6000 kg 13,200 lb	*13050 kg *28,800 lb	11900 kg 26,200 lb		

* Load is limited by hydraulic capacity rather than tipping. Ratings are based on SAE Standard No. J1097. Rated loads do not exceed 87% of hydraulic lift capacity or 75% of tipping load.



STANDARD EQUIPMENT

- Alternator, 35 Ampere, 24 V
- Auto-decel
- Automatic engine warm-up system
- Batteries, 110 Ah/2 x 12 V
- Boom holding valve
- Counterweight
- Dry type air cleaner, double element
- Electric horn
- EMMS monitoring system
- Engine, Komatsu SAA6D107E-1
- Engine overheat prevention system
- Fan guard structure
- Hydraulic track adjusters (each side)
- Multi-function color monitor
- Power maximizing system
- PPC hydraulic control system
- Radiator and oil cooler dust proof net
- Rear reflector
- Rearview mirrors (RH, LH, rear, sidewise)
- ROPS cab (ISO 12117-2)
- Slip-resistant plates
- Starting motor, 4.5 kW/24 V x 1
- Suction fan
- Track guiding guard, center section
- Track roller
 - PC200-8, 7 each side
 - PC200LC-8, 9 each side
- Track shoe
 - PC200-8, **600 mm** 24" triple grouser
 - PC200LC-8, **700 mm** 28" triple grouser
- Travel alarm
- Working light, 2 (boom and RH)
- Working mode selection system



OPTIONAL EQUIPMENT

- Additional filter system for poor-quality fuel
- Air conditioner with defroster
- Alternator, 60 Ampere, 24 V
- Arms
 - 2925 mm** 9'7" arm assembly
 - 2410 mm** 7'11" arm assembly
 - 1840 mm** 6'0" arm assembly
- Batteries, large capacity
- Bolt-on top guard, [Operator Protective Guards level 2]
- Boom, **5700 mm** 18'8"
- Cab accessories
 - Rain visor
 - Sun visor
- Cab front guard
 - Full height guard
 - Half height guard
- Heater with defroster
- Long lubricating intervals for work equipment bushing (500 hours)
- Rear view monitoring system
- Seat belt, retractable
- Seat, suspension
- Service valve
- Shoes, triple grouser
 - PC200-8: **500 mm** 20", **700 mm** 28", **800 mm** 31.5"
 - PC200LC-8: **600 mm** 24", **800 mm** 31.5", **900 mm** 35.5"
- Track frame undercover
- Track roller guards (full length)
- Working lights
 - 2 on cab
 - 1 on counterweight



SPECIAL PURPOSE BUCKET

- **Ditch cleaning bucket**
 - Capacity
 - SAE heaped **0.80 m³** 1.05 yd³
 - CECE heaped **0.70 m³** 0.92 yd³
 - Width **1800 mm** 70.9"
- **Trapezoidal bucket** is ideal for digging ditches and for drainage works
 - Capacity
 - SAE heaped **0.7 m³** 0.92 yd³
 - CECE heaped **0.5 m³** 0.65 yd³
- **Slope finishing bucket** for scraping slopes of banks
 - Capacity
 - SAE heaped **0.40 m³** 0.52 yd³
 - CECE heaped **0.35 m³** 0.46 yd³
 - Width **2000 mm** 78.7"
- **Ripper bucket** for hard and rock ground
 - Capacity
 - SAE heaped **0.62 m³** 0.81 yd³
 - CECE heaped **0.56 m³** 0.73 yd³
 - Width **990 mm** 39.0"
- **Single-shank ripper** and **three-shank ripper** are recommended for rock-digging and crushing, hard soil digging, pavement removal works, etc.

KOMATSU[®]